



94 JACKSON ROAD SUITE 110 DEVENS, MA 01434

TERMINATIONS

Model RMTE.8000Nm2
N male, Screw-on

FREQUENCY (MHz)	POWER (WATT)(avg)	IMPEDANCE (Ω)	VSWR (max)	WEIGHT (ounces)
DC-8000	2 1000W peak	50	1.25:1	0.21

Notes:

- Case Materials/Plating:
 Housing: Brass w/nickel plate
 Center Conductor: BeCu w/gold plate
 Insulator: PTFE
- Operation temperature: -65C to +125C deg
- Average power is derated linearly to 0.5W at 125°C
- Peak Power is based on 5 usec pulse, 0.05% duty cycle

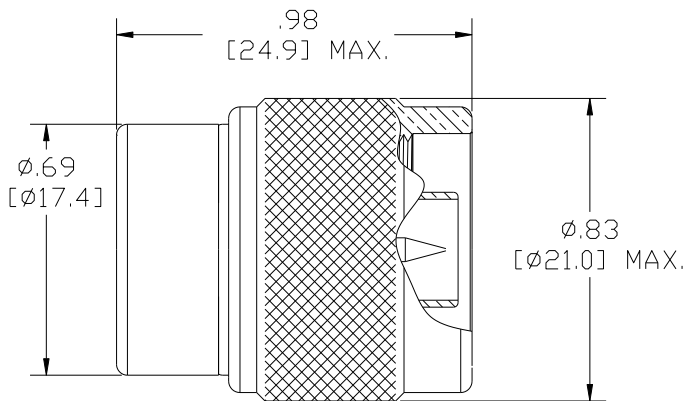

All specifications are subject to change without notice.

Telephone: 978-772-3767

Fax: 978-772-3768

www.responsemicrowave.com